

## 2/2-Wege Kunststoff -Magnetventil 2/2-way plastic solenoid valve

## Baureihe 150 Type 150

**direktgesteuert mit  
PTFE-Faltenbalg**  
*direct acting with  
PTFE-bellow*

Schaltfunktion A: NC (stromlos geschlossen)  
function A: NC (normally closed)

Schaltfunktion B: NO (stromlos offen)  
function B: NO (normally open)

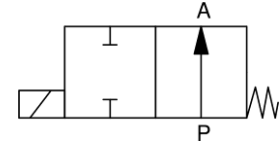
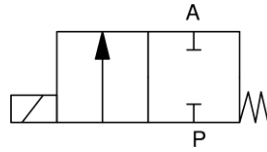

|                          |  |                           |  |
|--------------------------|--|---------------------------|--|
| <b>Bauart</b>            | Sitzventil mit PTFE-Faltenbalg   | <b>design</b>             | seat valve with PTFE bellow  |
| <b>Nennweite</b>         | DN 10 - 20   | <b>diameter</b>           | DN 10 - 20   |
| <b>Druckbereich</b>      | 0 - max. 2,0bar (siehe Tabelle)  | <b>pressure range</b>     | 0 - max. 2,0bar (see table)  |
| <b>Gehäusewerkstoff</b>  | PVC, PP, PTFE  | <b>body material</b>      | PVC, PP, PTFE  |
| <b>Dichtwerkstoff</b>    | EPDM, FKM, PTFE  | <b>seal material</b>      | EPDM, FKM, PTFE  |
| <b>Temperatur</b>        | siehe Druck- / Temperaturdiagramm & Temperaturbereich elastomerer Werkstoffe *<br>Umgebung: 0 bis max. +50°C | <b>temperature</b>        | see pressure- / temperature graph & temperature range elastomeric materials *<br>ambient: 0 up to max. +50°C |
| <b>Anschluss</b>         | PVC: Klebemuffe<br>PP: Schweißmuffe<br>PTFE: Gewindemuffe  | <b>connection</b>         | PVC: cementing socket<br>PP: welding socket<br>PTFE: threaded socket   |
| <b>Elektr. Anschluss</b> | Gerätesteckdose nach DIN EN 175301-803 Bauform A, bei Wechselstrombetrieb mit integriertem Gleichrichter     | <b>electr. connection</b> | plug acc.<br>DIN EN 175301-803 form A, a.c. operation with rectifier integrated                              |
| <b>Anschlussspannung</b> | 230V 50Hz, 24V DC, Sonderspannungen  | <b>nominal voltage</b>    | 230V 50Hz, 24V DC, special voltages  |
| <b>Spannungstoleranz</b> | + / - 10% nach VDE 0580  | <b>voltage tolerance</b>  | + / - 10% acc. VDE 0580  |
| <b>Leistungsaufnahme</b> | 230V 50Hz: 8,5W<br>24V DC: 7,5W  | <b>power consumption</b>  | 230V 50Hz: 8,5W<br>24V DC: 7,5W  |
| <b>Einschaltdauer</b>    | 100% ED  | <b>duty factor</b>        | 100% ED  |
| <b>Schutzart</b>         | IP 65 mit montierter Gerätesteckdose   | <b>protection class</b>   | IP 65 with plug mounted  |
| <b>Einbaulage</b>        | Magnet vorzugsweise oben   | <b>mounting</b>           | solenoid preferably in upright position  |

Technische Änderungen vorbehalten / modifications reserved

**Connexion Developments Ltd**

Unit 3 Rainbow Court · Yate Bristol - BS37 5NG · ☎ +44 (0) 1454 334 990 · 📠 +44 (0) 1454 326390 ·

[www.solenoid-valve.world](http://www.solenoid-valve.world) · [sales@solenoid-valves.com](mailto:sales@solenoid-valves.com) 1 / 5



**2/2-Wege Kunststoff -Magnetventil**  
**2/2-way plastic solenoid valve**

**Baureihe 150**  
**Type 150**

| DN<br>[mm] | Druck<br>pressure range<br>[bar] | Anschluss<br>connection<br>[mm]        |  |   | K <sub>v</sub> -Wert<br>flow rate<br>[l/min] | Gewicht<br>weight<br>[kg] |
|------------|----------------------------------|--|--|---|--|---------------------------|
|            |                                  | PVC:<br>Klebmunfte<br>cementing socket | PP:<br>Schweißmunfte<br>welding socket | PTFE:<br>Gewindemunfte<br>threaded socket |  |                           |
| 10         | 0 - 2,0                          | d 16                                   | d 16                                   | G3/8                                      | 20,7   | 1,0                       |
| 15         | 0 - 1,0                          | d 20                                   | d 20                                   | G1/2                                      | 29,7   | 1,0                       |
| 20         | 0 - 0,5                          | d 25                                   | d 25                                   | -   | 53,0   | 1,0                       |

**Schnittzeichnung**  
**sectional drawing**

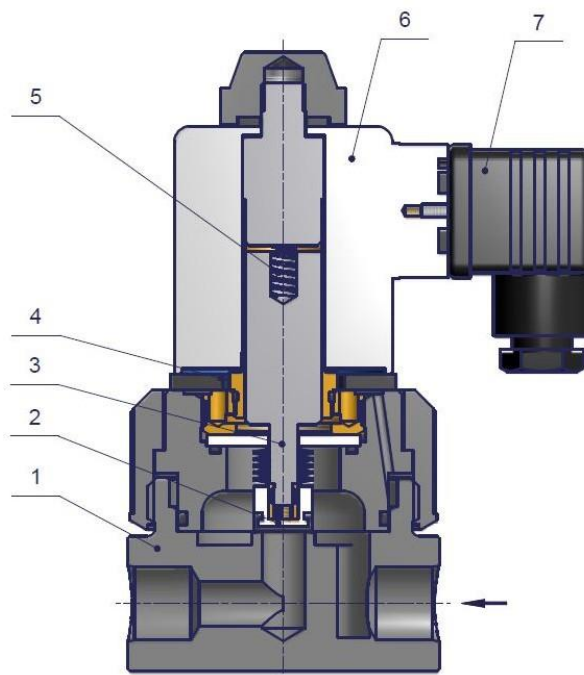

| Pos.<br>pos. | Menge<br>quantity | Benennung                      | description                    |
|--------------|-------------------|--------------------------------|--------------------------------|
| 1            | 1                 | Ventilkörper                   | valve body                     |
| 2            | 1                 | Dichtkappe                     | sealing cap                    |
| 3            | 1                 | Anker kpl. mit PTFE-Faltenbalg | plunger cpl. with PTFE bellows |
| 4            | 1                 | Magnetschluss-hülse            | solenoid tube                  |
| 5            | 1                 | Feder                          | spring                         |
| 6            | 1                 | Magnet                         | solenoid                       |
| 7            | 1                 | Gerätesteckdose                | plug                           |

Technische Änderungen vorbehalten / modifications reserved

**Connexion Developments Ltd**

Unit 3 Rainbow Court · Yate Bristol - BS37 5NG · ☎ +44 (0) 1454 334 990 · 📠 +44 (0) 1454 326390 ·

[www.solenoid-valve.world](http://www.solenoid-valve.world) · [sales@solenoid-valves.com](mailto:sales@solenoid-valves.com) 2 / 5

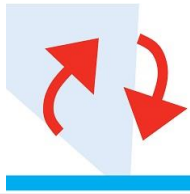

**2/2-Wege Kunststoff -Magnetventil**  
**2/2-way plastic solenoid valve**

**Baureihe 150**  
**Type 150**

**Maßzeichnung**  
**dimension drawing**

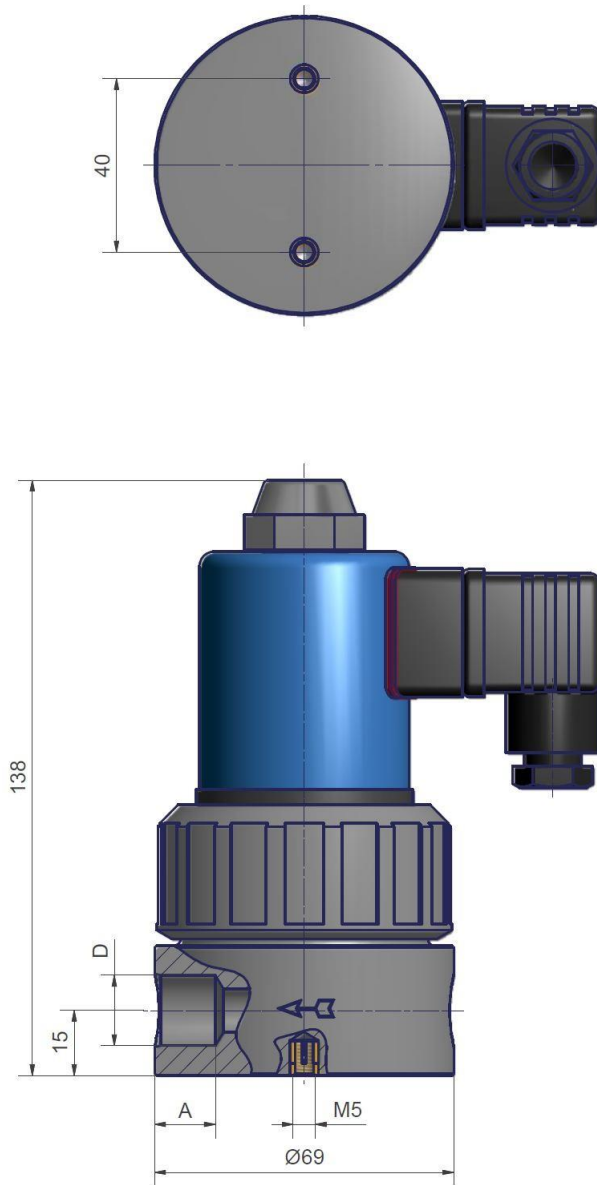

| DN | D<br>[mm] |      | A<br>[mm] |      |
|----|-----------|------|-----------|------|
|    | PVC / PP  | PTFE | PVC / PP  | PTFE |
| 10 | 16        | G3/8 | 14        | 13   |
| 15 | 20        | G1/2 | 16        | 13   |
| 20 | 25        | -    | 13        | -    |

Technische Änderungen vorbehalten / *modifications reserved*

**Connexion Developments Ltd**

Unit 3 Rainbow Court · Yate Bristol - BS37 5NG · ☎ +44 (0) 1454 334 990 · 📠 +44 (0) 1454 326390 ·

[www.solenoid-valve.world](http://www.solenoid-valve.world) · [sales@solenoid-valves.com](mailto:sales@solenoid-valves.com) 3 / 5

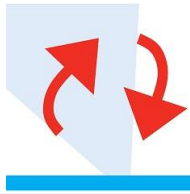

## 2/2-Wege Kunststoff -Magnetventil 2/2-way plastic solenoid valve

Baureihe 150  
Type 150

### Typenschlüssel type code

Die Typenbezeichnung setzt sich zusammen aus:  
structure of the order specification:

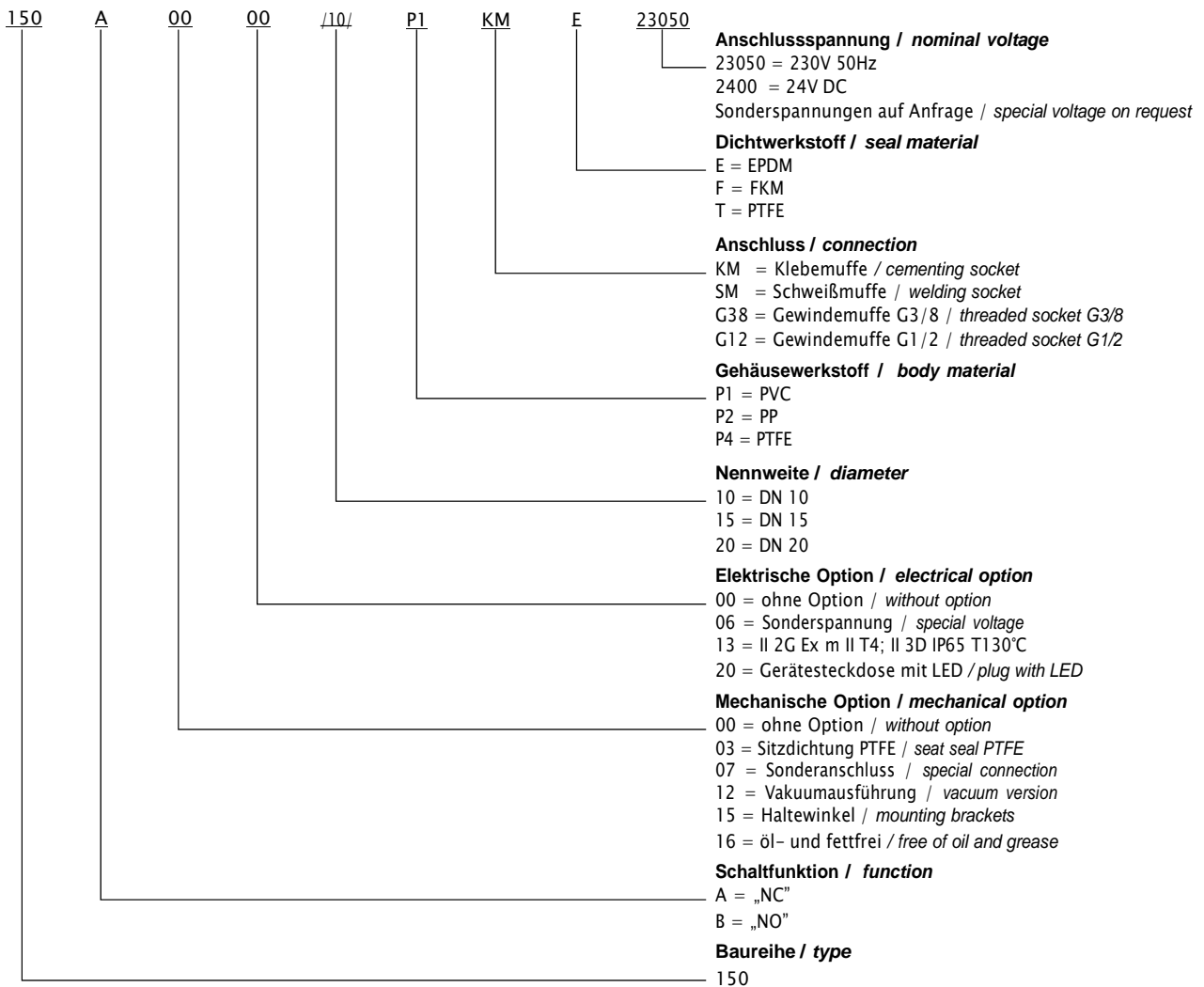

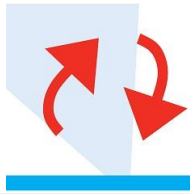







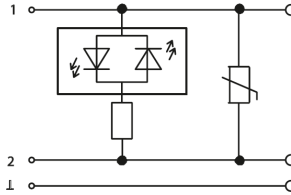

**2/2-Wege Kunststoff -Magnetventil**  
**2/2-way plastic solenoid valve**

**Baureihe 150**  
**Type 150**

**Zubehör**  
**accessories**

|   |  |  |
|---|--|--|
|    | <p><b>Haltewinkel</b><br/> <i>mounting brackets</i></p> <p><b>mechanische Option = 15</b><br/> <i>mechanical option = 15</i></p>   |   |
|    | <p><b>Gerätesteckdose mit LED</b><br/> <i>plug with LED</i></p> <p><b>elektrische Option = 20</b><br/> <i>electrical option = 20</i></p>   |    |
|  | <p><b>Sonderschutzart</b><br/> <i>explosion proof</i></p> <p><b>II 2G Ex m II T4</b><br/> <b>II 3D IP65 T130°C</b></p> <p><b>elektrische Option = 13</b><br/> <i>electrical option=13</i></p>        | <p><b>der Betriebsdruck ist bei Ex-Ausführung um ca. 20% reduziert</b><br/> <i>operating pressure is reduced about 20% in Ex specification</i></p> |
|  | <p><b>Gerätesteckdose mit angespritztem Kabel</b><br/> <i>plug with cable</i></p>  |  |
|  | <p><b>Gerätesteckdose M12x1</b><br/> <i>plug with M12x1</i></p>  |  |
|  | <p><b>Gerätesteckdose mit Leistungsabsenkung 24V DC, Bauform A</b><br/> <i>plug with power reduction 24V DC, form A</i></p> <p><b>elektrische Option = 07</b><br/> <i>electrical option = 07</i></p> |    |

**Weitere Optionen und Zubehör stimmen wir gerne auf Ihre Anforderungen ab.**  
*We gladly coordinate further options and accessories according to your requirements.*